

STRAIGHT JACK CRIMP TYPE

R125.222.901

CABLE .085

Series : SMA

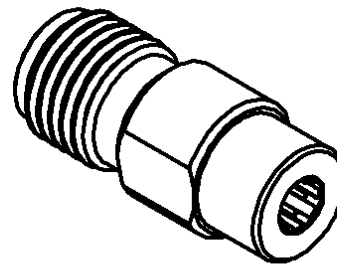
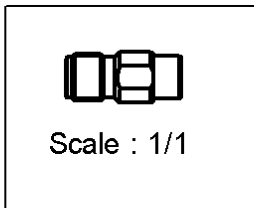
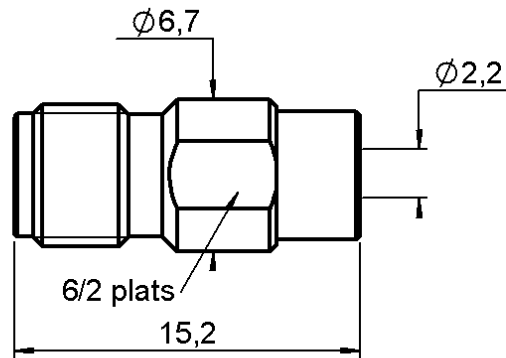

All dimensions are in mm.



COMPONENTS	MATERIALS	PLATINGS (μm)
BODY	STAINLESS STEEL	PASSIVATED .
CENTER CONTACT	BERYLLIUM COPPER	GOLD 1.3 OVER NICKEL 2
OUTER CONTACT	-	-
INSULATOR	PTFE	-
GASKET	-	-
OTHERS PARTS	STAINLESS STEEL	PASSIVATED .
-	-	-
-	-	-

Issue : 0039 C

In the effort to improve our products, we reserve the right to make changes judged to be necessary.



STRAIGHT JACK CRIMP TYPE

R125.222.901

CABLE .085

Series : SMA

PACKAGING

Standard	Unit	Other
100	'W' option	Contact us

SPECIFICATION

CABLE ASSEMBLY

ELECTRICAL CHARACTERISTICS

Stripping	a	b	c	d	e	f
mm	1.78	0.00	0.00	0.00	0.00	0.00

Impedance		50	Ω
Frequency		0-18	GHz
VSWR	1.07 +	0.010	x F(GHz) Maxi
Insertion loss		0.03	\sqrt{F} (GHz) dB Maxi
RF leakage	- (60	- F(GHz)) dB mini
Voltage rating		335	Veff Maxi
Dielectric withstanding voltage		750	Veff mini
Insulation resistance		5000	M Ω mini

Assembly instruction :

Recommended cable(s)
KS 1
RG 405

Cable retention

- pull off **130** N mini
- torque **NA** N.cm

MECHANICAL CHARACTERISTICS

TOOLING

Center contact retention			
Axial force – Mating end		27	N mini
Axial force – Opposite end		27	N mini
Torque		2.8	N.cm mini

Part Number	Description	Hexagon
.	.	.
R282.286.000	CRIMPING TOOL	-
R282.703.000	POSITIONER	-
R282.255.000	PNEUMATIC CRIMPING TOOL	
R282.711.000	GUIDE	

Recommended torque			
Mating		NA	N.cm
Panel nut		NA	N.cm
Clamp nut		NA	N.cm
A/F clamp nut		0.000	mm

OTHERS CHARACTERISTICS

Mating life		500	Cycles mini
Weight		2.700	g

ENVIRONMENTAL

Operating temperature		-65/+105	$^{\circ}$ C
Hermetic seal		NA	Atm.cm3/s
Panel leakage		NA	

Issue : 0039 C

In the effort to improve our products, we reserve the right to make changes judged to be necessary.



STRAIGHT JACK CRIMP TYPE

R125.222.901

CABLE .085

Series : SMA

COMPONENTS

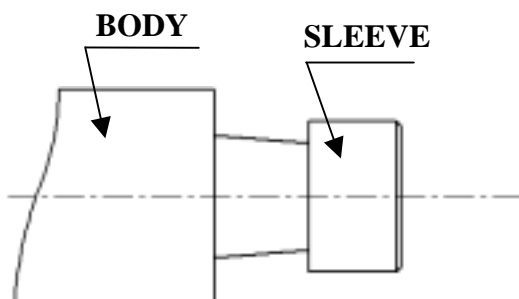

STIPPING DIMENSIONS

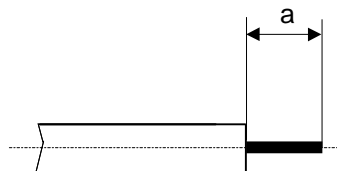

1

- Strip the cable with the cable stripping tool
- Trim the cable inner conductor with the trimmer.

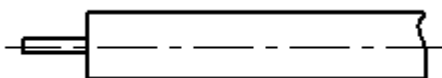

3

- Insert the connector and the cable on the crimping tool with guide and positioner.
- A pneumatic crimping tool exist too that can be used

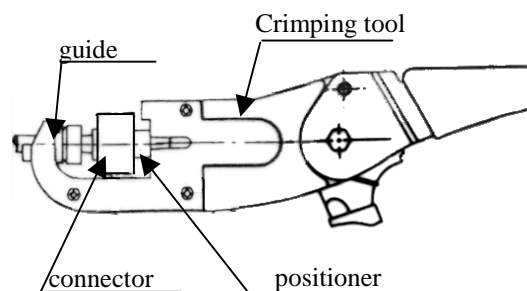

2

- Slide connector onto the cable

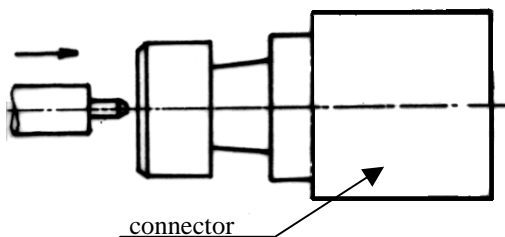

4

- Press the connector on the cable.

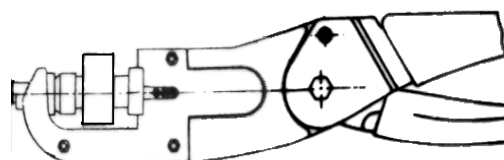

Issue : 0039 C

In the effort to improve our products, we reserve the right to make changes judged to be necessary.

